

**1A LOW DROPOUT LINEAR REGULATOR****AZ1117****General Description**

The AZ1117 is a series of low dropout three-terminal regulators with a dropout of 1.15V at 1A output current.

The AZ1117 series provides current limiting and thermal shutdown. Its circuit includes a trimmed bandgap reference to assure output voltage accuracy to be within 1%. Current limit is trimmed to ensure specified output current and controlled short-circuit current. On-chip thermal shutdown provides protection against any combination of overload and ambient temperature that would create excessive junction temperature.

The AZ1117 has an adjustable version, that can provide the output voltage from 1.25V to 12V with only 2 external resistors.

The AZ1117 series is available in the industry standard SOT-223, SOT-89, TO-220, TO-252 and TO-263 power packages.

**Features**

- Low Dropout Voltage: 1.15V at 1A Output Current
- Trimmed Current Limit
- On-Chip Thermal Shutdown
- Three-Terminal Adjustable or Fixed 1.5V, 1.8V, 2.5V, 3.3V, 5V
- Operation Junction Temperature: 0 to 125°C

**Applications**

- PC Motherboard
- LCD Monitor
- Graphic Card
- DVD-Video Player
- NIC/Switch
- Telecom Equipment
- ADSL Modem
- Printer and other Peripheral Equipment

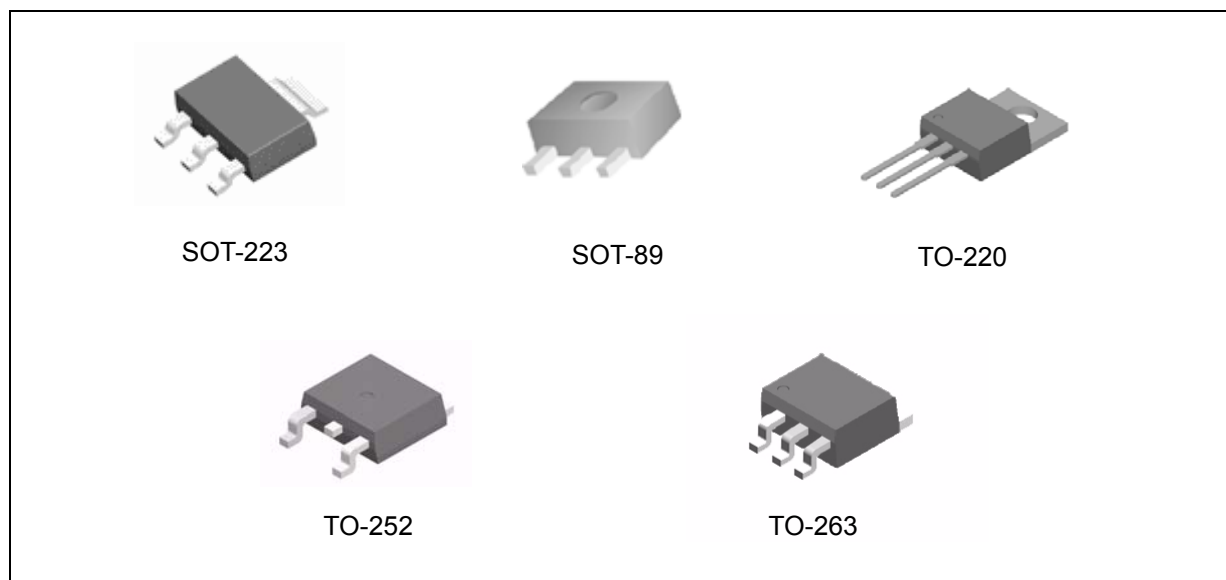

Figure 1. Package Types of AZ1117



**1A LOW DROPOUT LINEAR REGULATOR**

**AZ1117**

**Pin Configurations**

H Package  
(SOT-223)

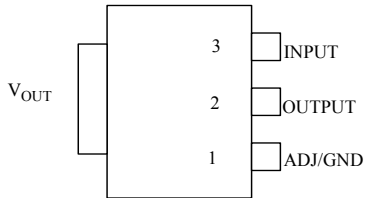

R Package  
(SOT-89)

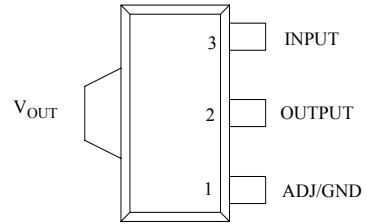

T Package  
(TO-220)

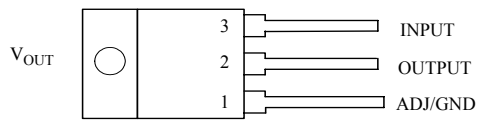

D Package  
(TO-252)

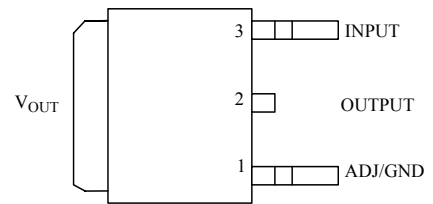

S Package  
(TO-263)

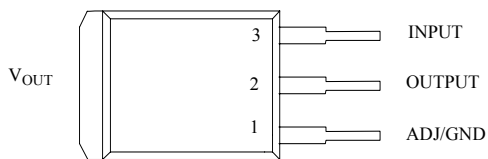

Figure 2. Pin Configurations of AZ1117



**1A LOW DROPOUT LINEAR REGULATOR**

**AZ1117**

**Functional Block Diagram**

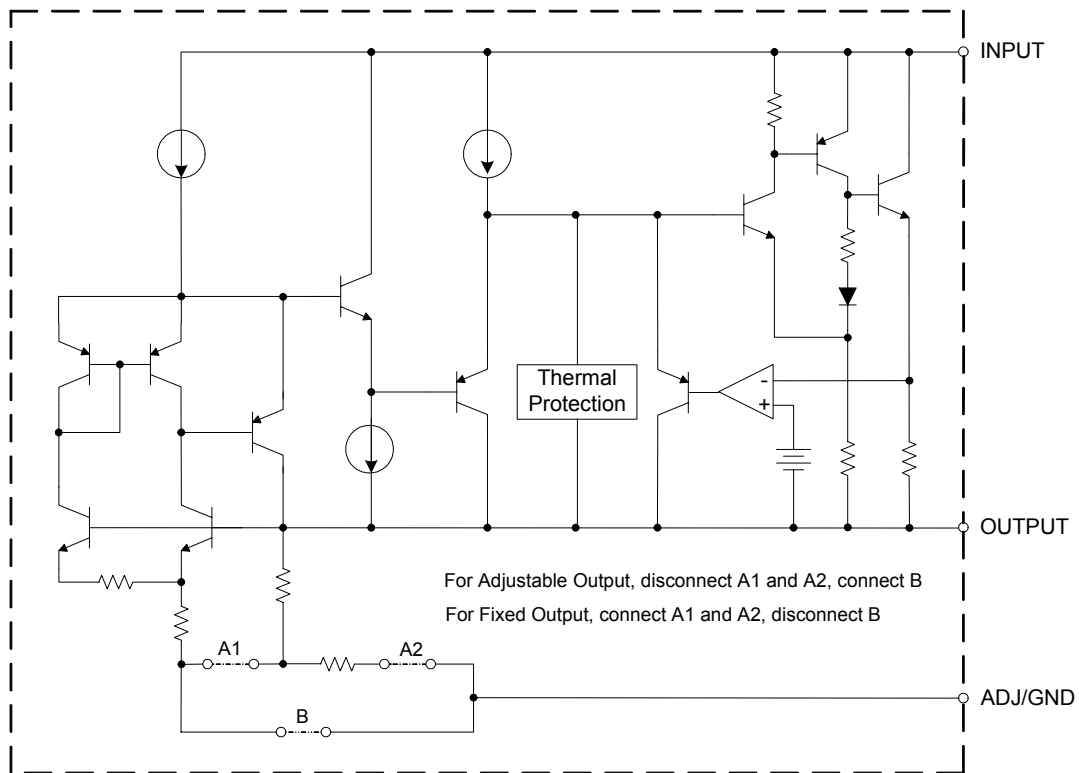

Figure 3. Functional Block Diagram of AZ1117



**1A LOW DROPOUT LINEAR REGULATOR**

**AZ1117**

**Ordering Information**

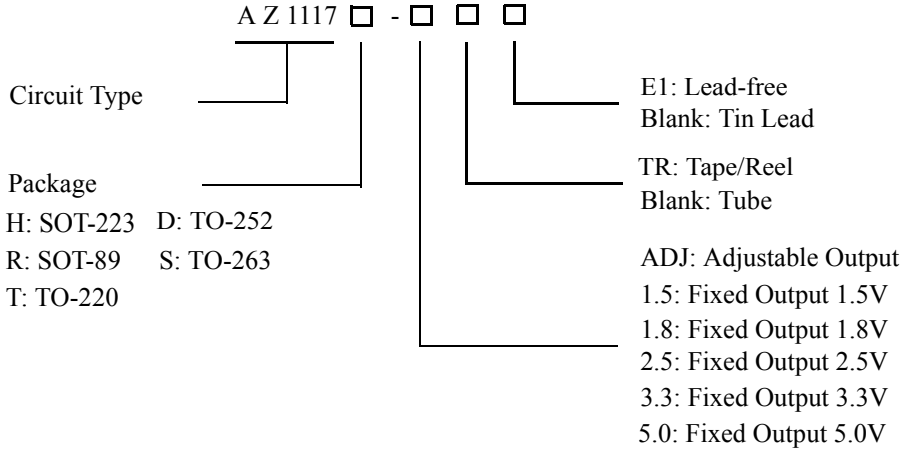

Package	Temperature Range	Part Number		Marking ID		Packing Type
		Tin Lead	LeadFree	Tin Lead	LeadFree	
SOT-223	0 to 125°C	AZ1117H-ADJTR	AZ1117H-ADJTRE1	H11A	EH11A	Tape/Reel
		AZ1117H-1.5TR	AZ1117H-1.5TRE1	H12A	EH12A	Tape/Reel
		AZ1117H-1.8TR	AZ1117H-1.8TRE1	H13A	EH13A	Tape/Reel
		AZ1117H-2.5TR	AZ1117H-2.5TRE1	H14A	EH14A	Tape/Reel
		AZ1117H-3.3TR	AZ1117H-3.3TRE1	H16A	EH16A	Tape/Reel
		AZ1117H-5.0TR	AZ1117H-5.0TRE1	H17A	EH17A	Tape/Reel
SOT-89	0 to 125°C	AZ1117R-ADJTR	AZ1117R-ADJTRE1	R17A	E17A	Tape/Reel
		AZ1117R-1.5TR	AZ1117R-1.5TRE1	R17B	E17B	Tape/Reel
		AZ1117R-1.8TR	AZ1117R-1.8TRE1	R17C	E17C	Tape/Reel
		AZ1117R-2.5TR	AZ1117R-2.5TRE1	R17D	E17D	Tape/Reel
		AZ1117R-3.3TR	AZ1117R-3.3TRE1	R17E	E17E	Tape/Reel
		AZ1117R-5.0TR	AZ1117R-5.0TRE1	R17F	E17F	Tape/Reel
TO-220	0 to 125°C	AZ1117T-ADJ	AZ1117T-ADJE1	AZ1117T-ADJ	AZ1117T-ADJE1	Tube
		AZ1117T-1.5	AZ1117T-1.5E1	AZ1117T-1.5	AZ1117T-1.5E1	Tube
		AZ1117T-1.8	AZ1117T-1.8E1	AZ1117T-1.8	AZ1117T-1.8E1	Tube
		AZ1117T-2.5	AZ1117T-2.5E1	AZ1117T-2.5	AZ1117T-2.5E1	Tube
		AZ1117T-3.3	AZ1117T-3.3E1	AZ1117T-3.3	AZ1117T-3.3E1	Tube
		AZ1117T-5.0	AZ1117T-5.0E1	AZ1117T-5.0	AZ1117T-5.0E1	Tube
TO-252	0 to 125°C	AZ1117D-ADJ	AZ1117D-ADJE1	AZ1117D-ADJ	AZ1117D-ADJE1	Tube
		AZ1117D-ADJTR	AZ1117D-ADJTRE1	AZ1117D-ADJ	AZ1117D-ADJE1	Tape/Reel
		AZ1117D-1.5	AZ1117D-1.5E1	AZ1117D-1.5	AZ1117D-1.5E1	Tube
		AZ1117D-1.5TR	AZ1117D-1.5TRE1	AZ1117D-1.5	AZ1117D-1.5E1	Tape/Reel
		AZ1117D-1.8	AZ1117D-1.8E1	AZ1117D-1.8	AZ1117D-1.8E1	Tube
		AZ1117D-1.8TR	AZ1117D-1.8TRE1	AZ1117D-1.8	AZ1117D-1.8E1	Tape/Reel

**1A LOW DROPOUT LINEAR REGULATOR****AZ1117****Ordering Information (Continued)**

Package	Temperature Range	Part Number		Marking ID		Packing Type
		Tin Lead	Lead Free	Tin Lead	Lead Free	
TO-252	0 to 125°C	AZ1117D-2.5	AZ1117D-2.5E1	AZ1117D-2.5	AZ1117D-2.5E1	Tube
		AZ1117D-2.5TR	AZ1117D-2.5TRE1	AZ1117D-2.5	AZ1117D-2.5E1	Tape/Reel
		AZ1117D-3.3	AZ1117D-3.3E1	AZ1117D-3.3	AZ1117D-3.3E1	Tube
		AZ1117D-3.3TR	AZ1117D-3.3TRE1	AZ1117D-3.3	AZ1117D-3.3E1	Tape/Reel
		AZ1117D-5.0	AZ1117D-5.0E1	AZ1117D-5.0	AZ1117D-5.0E1	Tube
		AZ1117D-5.0TR	AZ1117D-5.0TRE1	AZ1117D-5.0	AZ1117D-5.0E1	Tape/Reel
TO-263	0 to 125°C	AZ1117S-ADJ	AZ1117S-ADJE1	AZ1117S-ADJ	AZ1117S-ADJE1	Tube
		AZ1117S-ADJTR	AZ1117S-ADJTRE1	AZ1117S-ADJ	AZ1117S-ADJE1	Tape/Reel
		AZ1117S-1.5	AZ1117S-1.5E1	AZ1117S-1.5	AZ1117S-1.5E1	Tube
		AZ1117S-1.5TR	AZ1117S-1.5TRE1	AZ1117S-1.5	AZ1117S-1.5E1	Tape/Reel
		AZ1117S-1.8	AZ1117S-1.8E1	AZ1117S-1.8	AZ1117S-1.8E1	Tube
		AZ1117S-1.8TR	AZ1117S-1.8TRE1	AZ1117S-1.8	AZ1117S-1.8E1	Tape/Reel
		AZ1117S-2.5	AZ1117S-2.5E1	AZ1117S-2.5	AZ1117S-2.5E1	Tube
		AZ1117S-2.5TR	AZ1117S-2.5TRE1	AZ1117S-2.5	AZ1117S-2.5E1	Tape/Reel
		AZ1117S-3.3	AZ1117S-3.3E1	AZ1117S-3.3	AZ1117S-3.3E1	Tube
		AZ1117S-3.3TR	AZ1117S-3.3TRE1	AZ1117S-3.3	AZ1117S-3.3E1	Tape/Reel
		AZ1117S-5.0	AZ1117S-5.0E1	AZ1117S-5.0	AZ1117S-5.0E1	Tube
		AZ1117S-5.0TR	AZ1117S-5.0TRE1	AZ1117S-5.0	AZ1117S-5.0E1	Tape/Reel

The listed part numbers are used during the transition to lead-free products. After the transition completed, lead-free products will be considered as the "standard" and we will resume the original part numbers.

**1A LOW DROPOUT LINEAR REGULATOR****AZ1117****Absolute Maximum Ratings (Note 1)**

Parameter	Symbol	Min	Max	Unit
Input Voltage	$V_{IN}$		20	V
Maximum Junction Temperature	$T_J$		150	°C
Storage Temperature	$T_S$	-65	150	°C
Lead Temperature (Soldering, 10 sec.)	$T_{LEAD}$		300	°C
ESD (Machine Model)	ESD		600	V

Note 1: Stresses greater than those listed under "Absolute Maximum Ratings" may cause permanent damage to the device. These are stress ratings only, and functional operation of the device at these or any other conditions beyond those indicated under "Recommended Operating Conditions" is not implied. Exposure to "Absolute Maximum Ratings" for extended periods may affect device reliability.

**Recommended Operating Conditions**

Parameter	Symbol	Min	Max	Unit
Input Voltage	$V_{IN}$		15	V
Operating Junction Temperature Range	$T_J$	0	125	°C



**1A LOW DROPOUT LINEAR REGULATOR**

**AZ1117**

**Electrical Characteristics**

Operating Conditions:  $V_{IN} \leq 10V$ ,  $T_J = 25^\circ C$  unless otherwise specified.

Parameter	Symbol	Conditions	Min	Typ	Max	Unit
Reference Voltage	$V_{REF}$	AZ1117-ADJ $I_{OUT} = 10mA$ , $V_{IN} - V_{OUT} = 2V$ $10mA \leq I_{OUT} \leq 1A$ , $1.4V \leq V_{IN} - V_{OUT} \leq 8V$ , $P \leq$ Maximum Power Dissipation	1.238 1.225	1.250 1.250	1.262 1.270	V
Output Voltage	$V_{OUT}$	AZ1117-1.5, $I_{OUT} = 10mA$ , $V_{IN} = 3.5V$ $10mA \leq I_{OUT} \leq 1A$ , $3.0V \leq V_{IN} \leq 10V$	1.485 1.470	1.5 1.5	1.515 1.530	V
		AZ1117-1.8, $I_{OUT} = 10mA$ , $V_{IN} = 3.8V$ $10mA \leq I_{OUT} \leq 1A$ , $3.2V \leq V_{IN} \leq 10V$	1.782 1.746	1.8 1.8	1.818 1.854	V
		AZ1117-2.5, $I_{OUT} = 10mA$ , $V_{IN} = 4.5V$ $10mA \leq I_{OUT} \leq 1A$ , $3.9V \leq V_{IN} \leq 10V$	2.475 2.450	2.5 2.5	2.525 2.550	V
		AZ1117-3.3, $I_{OUT} = 10mA$ , $V_{IN} = 5.0V$ $10mA \leq I_{OUT} \leq 1A$ , $4.75V \leq V_{IN} \leq 10V$	3.267 3.235	3.3 3.3	3.333 3.365	V
		AZ1117-5.0, $I_{OUT} = 10mA$ , $V_{IN} = 7.0V$ $10mA \leq I_{OUT} \leq 1A$ , $6.5V \leq V_{IN} \leq 12V$	4.950 4.900	5.0 5.0	5.050 5.100	V
Line Regulation	$\Delta V_{OUT}$	AZ1117-ADJ $I_{OUT} = 10mA$ , $1.5V \leq V_{IN} - V_{OUT} \leq 10V$		0.035	0.2	%
		AZ1117-1.5 $I_{OUT} = 10mA$ , $1.5V \leq V_{IN} - V_{OUT} \leq 10V$		1	6	mV
		AZ1117-1.8 $I_{OUT} = 10mA$ , $1.5V \leq V_{IN} - V_{OUT} \leq 10V$		1	6	mV
		AZ1117-2.5 $I_{OUT} = 10mA$ , $1.5V \leq V_{IN} - V_{OUT} \leq 10V$		1	6	mV
		AZ1117-3.3 $I_{OUT} = 10mA$ , $1.5V \leq V_{IN} - V_{OUT} \leq 10V$		1	6	mV
		AZ1117-5.0 $I_{OUT} = 10mA$ , $1.5V \leq V_{IN} - V_{OUT} \leq 10V$		1	10	mV
Load Regulation	$\Delta V_{OUT}$	AZ1117-ADJ $V_{IN} - V_{OUT} = 2V$ , $10mA \leq I_{OUT} \leq 1A$		0.2	0.4	%
		AZ1117-1.5 $V_{IN} - V_{OUT} = 2V$ , $10mA \leq I_{OUT} \leq 1A$		1	10	mV
		AZ1117-1.8 $V_{IN} - V_{OUT} = 2V$ , $10mA \leq I_{OUT} \leq 1A$		1	10	mV
		AZ1117-2.5 $V_{IN} - V_{OUT} = 2V$ , $10mA \leq I_{OUT} \leq 1A$		1	10	mV
		AZ1117-3.3 $V_{IN} - V_{OUT} = 2V$ , $10mA \leq I_{OUT} \leq 1A$		1	10	mV
		AZ1117-5.0 $V_{IN} - V_{OUT} = 2V$ , $10mA \leq I_{OUT} \leq 1A$		1	15	mV



**1A LOW DROPOUT LINEAR REGULATOR**

**AZ1117**

**Electrical Characteristics (Continued)**

Operating Conditions:  $V_{IN} \leq 10V$ ,  $T_J = 25^\circ C$  unless otherwise specified.

Parameter	Symbol	Conditions	Min	Typ	Max	Unit
Dropout Voltage		$\Delta V_{REF} = 1\%, I_{OUT} = 0.1A$		1.00	1.1	V
		$\Delta V_{REF} = 1\%, I_{OUT} = 0.5A$		1.08	1.18	V
		$\Delta V_{REF} = 1\%, I_{OUT} = 1.0A$		1.15	1.25	V
Current Limit	$I_{LIMIT}$	$V_{IN} - V_{OUT} = 2V$	1.25	1.35		A
Adjust Pin Current				60	120	$\mu A$
Adjust Pin Current Change		$1.4V \leq V_{IN} - V_{OUT} \leq 10V, 10mA \leq I_{OUT} \leq 1A$		0.2	5	$\mu A$
Minimum Load Current (ADJ)		$1.5V \leq V_{IN} - V_{OUT} \leq 10V$ (ADJ only)		1.7	5	mA
Quiescent Current		$V_{IN} = V_{OUT} + 1.25V$		5	10	mA
Ripple Rejection		$f = 120Hz, C_{OUT} = 22\mu F$ Tantalum, $V_{IN} - V_{OUT} = 3V, I_{OUT} = 1A$	60	75		dB
Temperature Stability				0.5		%
Long -Term Stability		$T_A = 125^\circ C, 1000hrs$		0.3		%
RMS Output Noise (% of $V_{OUT}$ )		$T_A = 25^\circ C, 10Hz \leq f \leq 10kHz$		0.003		%
Thermal Resistance, Junction to Case	$\theta_{JC}$	SOT-223 TO-252 TO-220 TO-263		15 10 4.5 4		$^\circ C/W$
Thermal Shutdown		Junction Temperature		150		$^\circ C$
Thermal Shutdown Hysteresis				25		$^\circ C$





**1A LOW DROPOUT LINEAR REGULATOR**

**AZ1117**

**Typical Performance Characteristics**

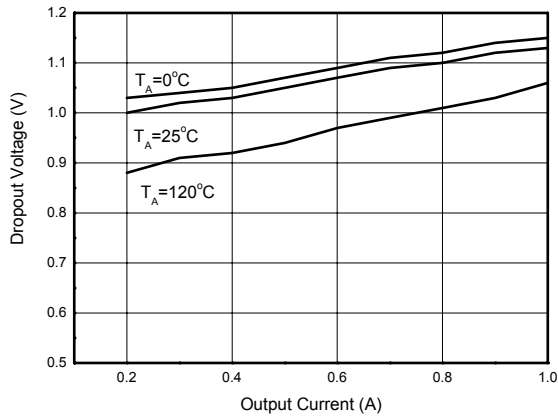

Figure 4. Dropout Voltage vs. Output Current

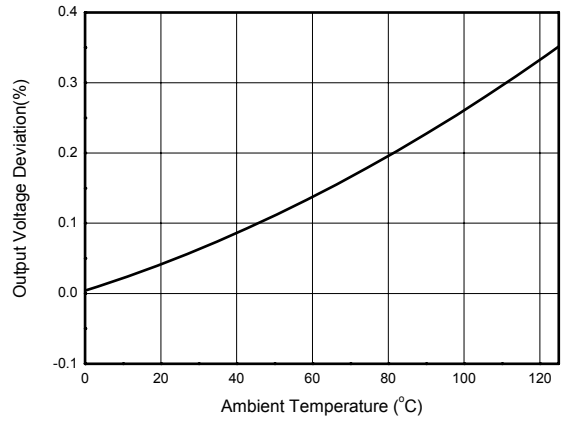

Figure 5. Load Regulation vs. Temperature

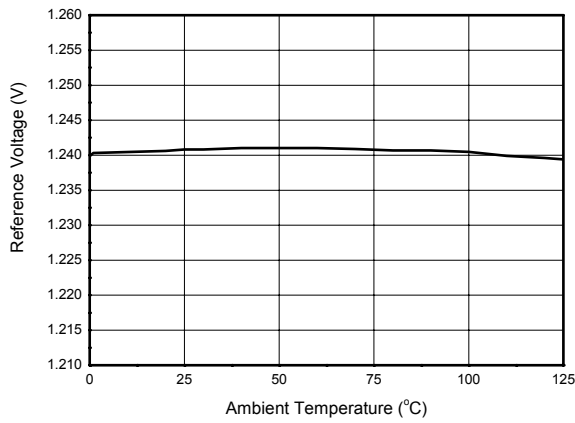

Figure 6. Reference Voltage vs. Temperature

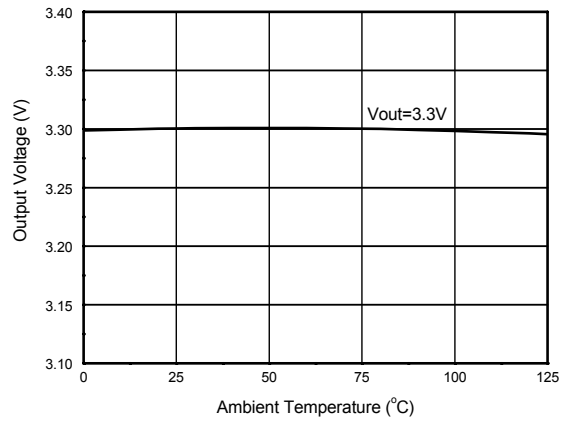

Figure 7. Output Voltage vs. Temperature



**1A LOW DROPOUT LINEAR REGULATOR**

**AZ1117**

**Typical Performance Characteristics (Continued)**

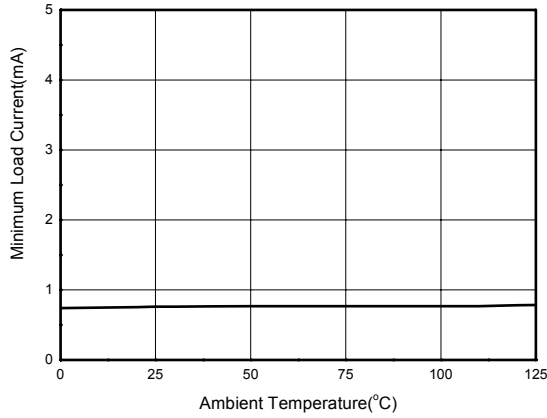

Figure 8. Minimum Load Current vs. Temperature

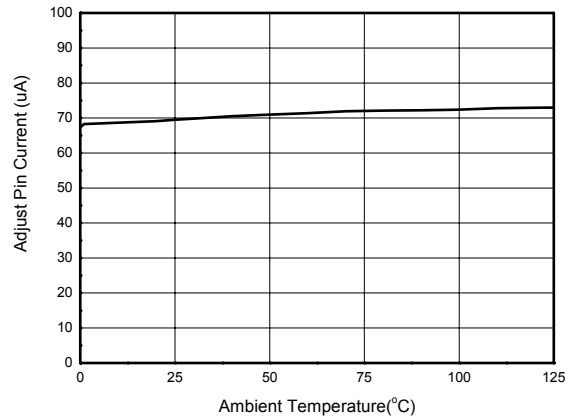

Figure 9. Adjust Pin Current vs. Temperature

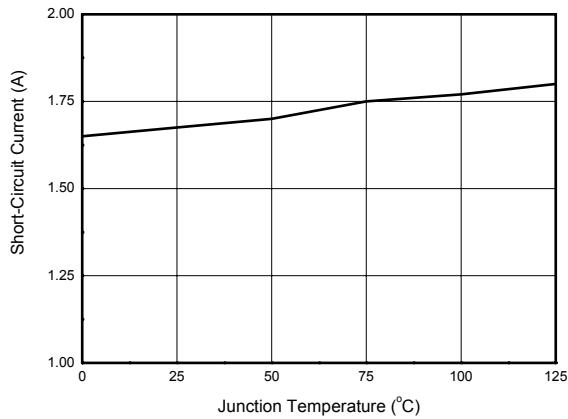

Figure 10. Short-Circuit Current vs. Temperature

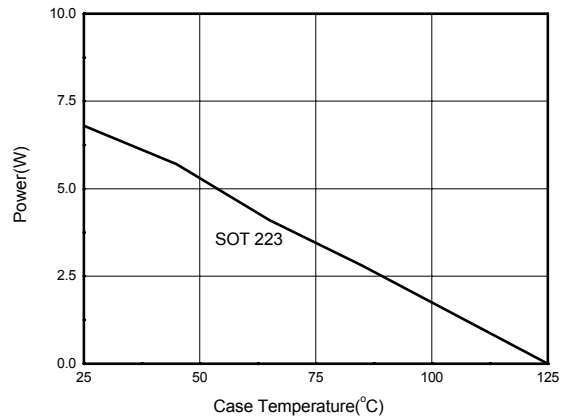

Figure 11. Maximum Power Dissipation



**1A LOW DROPOUT LINEAR REGULATOR**

**AZ1117**

**Typical Performance Characteristics (Continued)**

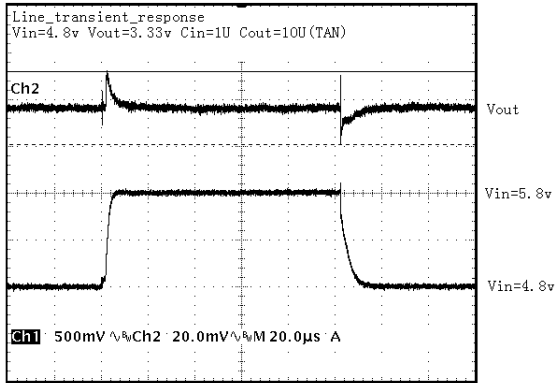

Figure 12. Line Transient Response

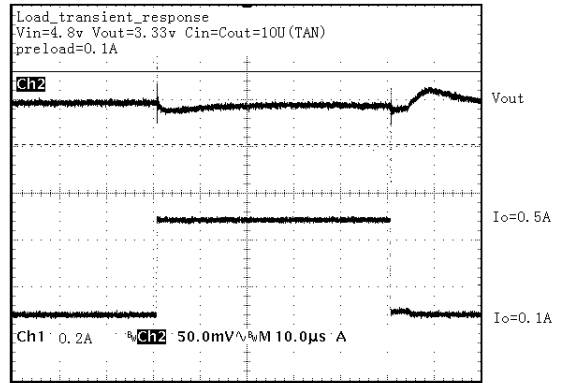

Figure 13. Load Transient Response

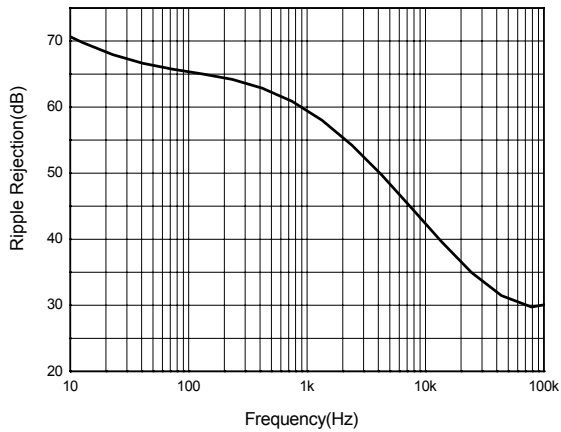

Figure 14. Ripple Rejection vs. Frequency



**1A LOW DROPOUT LINEAR REGULATOR**

**AZ1117**

**Typical Applications**

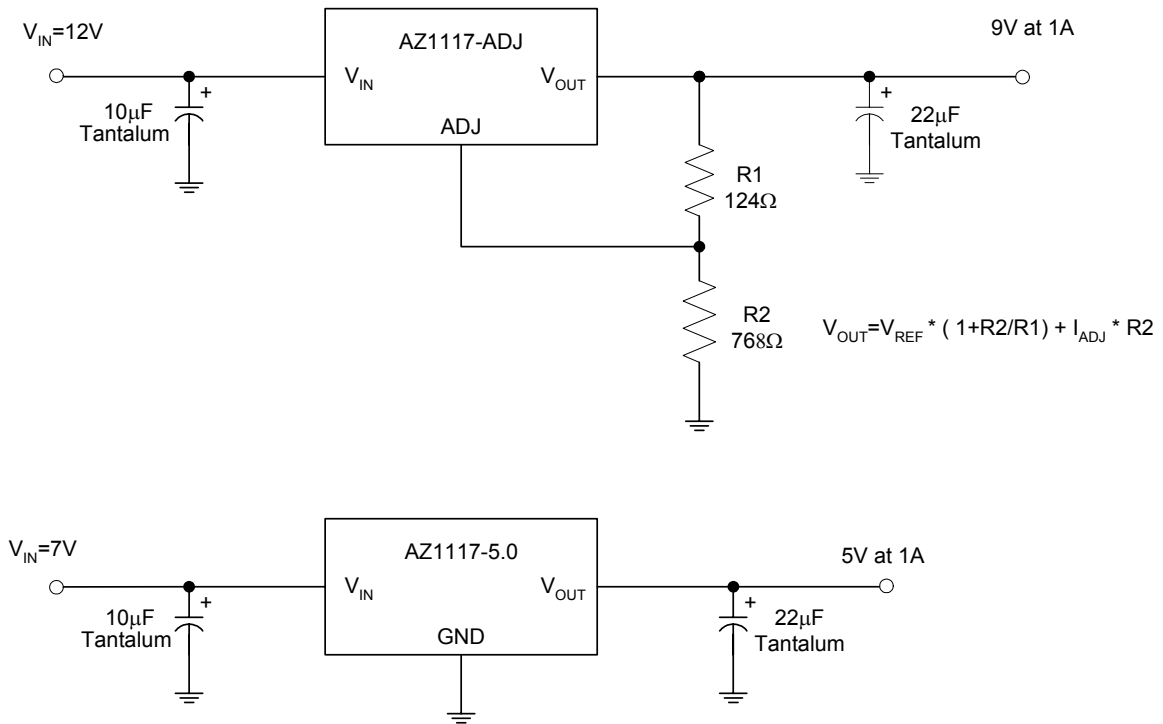

Figure 15. Typical Applications of AZ1117